

# Activity 1 Prophet Adam عليه السلام

My Name is:

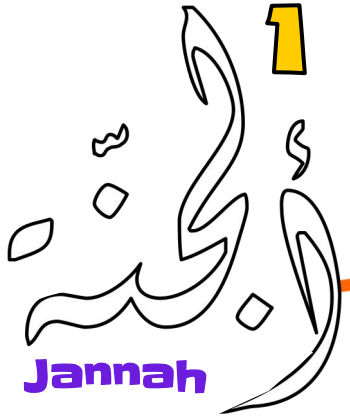

Jannah

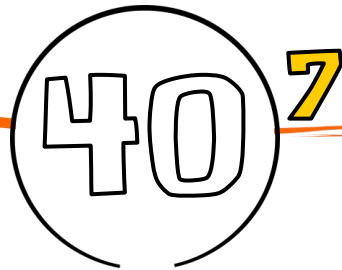
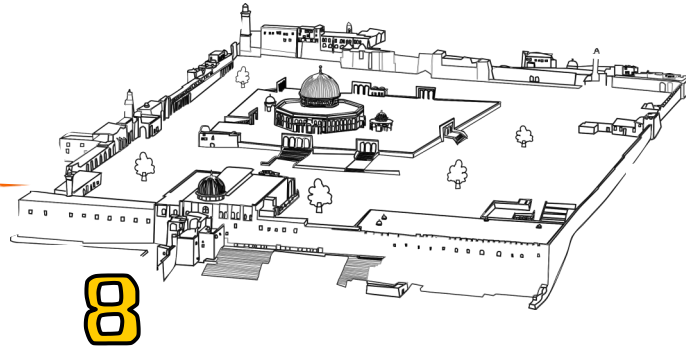
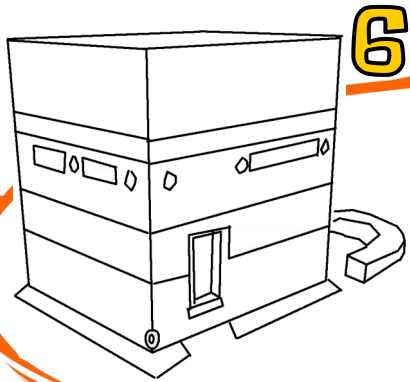
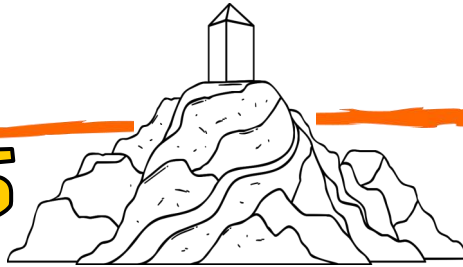

Can you re-tell the story using the pictures?

# The Story of Adam عليه السلام ...

Prophet Adam عليه السلام was the first man and also the first prophet created by Allah سبحانه وتعالى. Allah سبحانه وتعالى made Adam عليه السلام from soil. Hawa عليها السلام was then created to be his wife. Adam عليه السلام and Hawa عليها السلام the parents of all humans.

## Iblis



The Shaytan (Iblis) became the enemy of Adam عليه السلام. Shaytan would try to trick them to do things which would be disobeying Allah سبحانه وتعالى.



## The Tree

Allah سبحانه وتعالى told Adam عليه السلام not to eat from a tree in Jannah. However, Shaytan tricked Adam عليه السلام and Hawa عليها السلام and they ate from the tree .

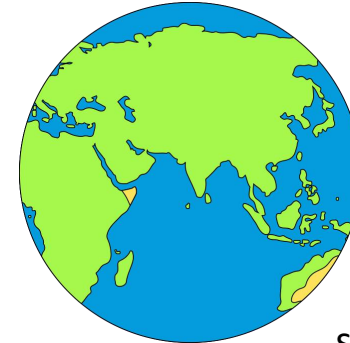

## Earth

Allah سبحانه وتعالى sent Adam عليه السلام and Hawa عليها السلام to Earth. They stayed on Earth and asked Allah سبحانه وتعالى for forgiveness. Allah سبحانه وتعالى forgave them both.

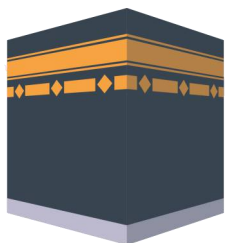

Allah سبحانه وتعالى sent Adam عليه السلام and Hawa عليها السلام to Earth where they lived together. Allah سبحانه وتعالى told Prophet Adam عليه السلام to build the Ka'bah in Makkah. Forty years later, Allah سبحانه وتعالى told Adam عليه السلام to build Masjid Al-Aqsa in Jerusalem.

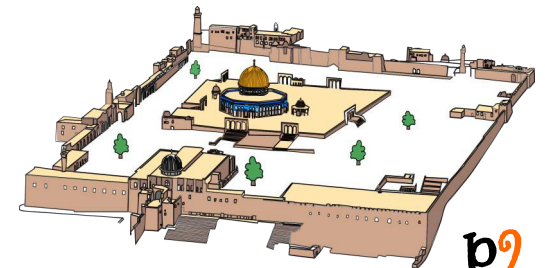

# From Makkah to Jerusalem

Help me get to Jerusalem to visit Masjid Al-Aqsa

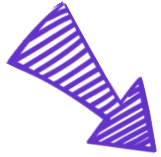

## The Ka'bah

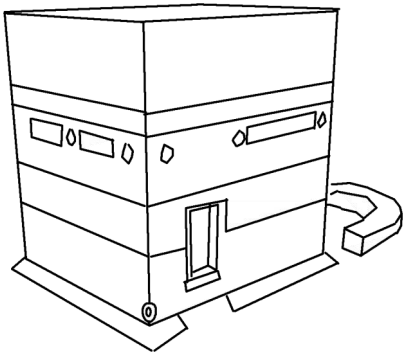

This was the first place of worship built by Prophet Adam عليه السلام.

Adam عليه السلام built the Ka'bah in Makkah. The Ka'bah is a sacred and blessed place. Even today it remains the most important place on Earth.

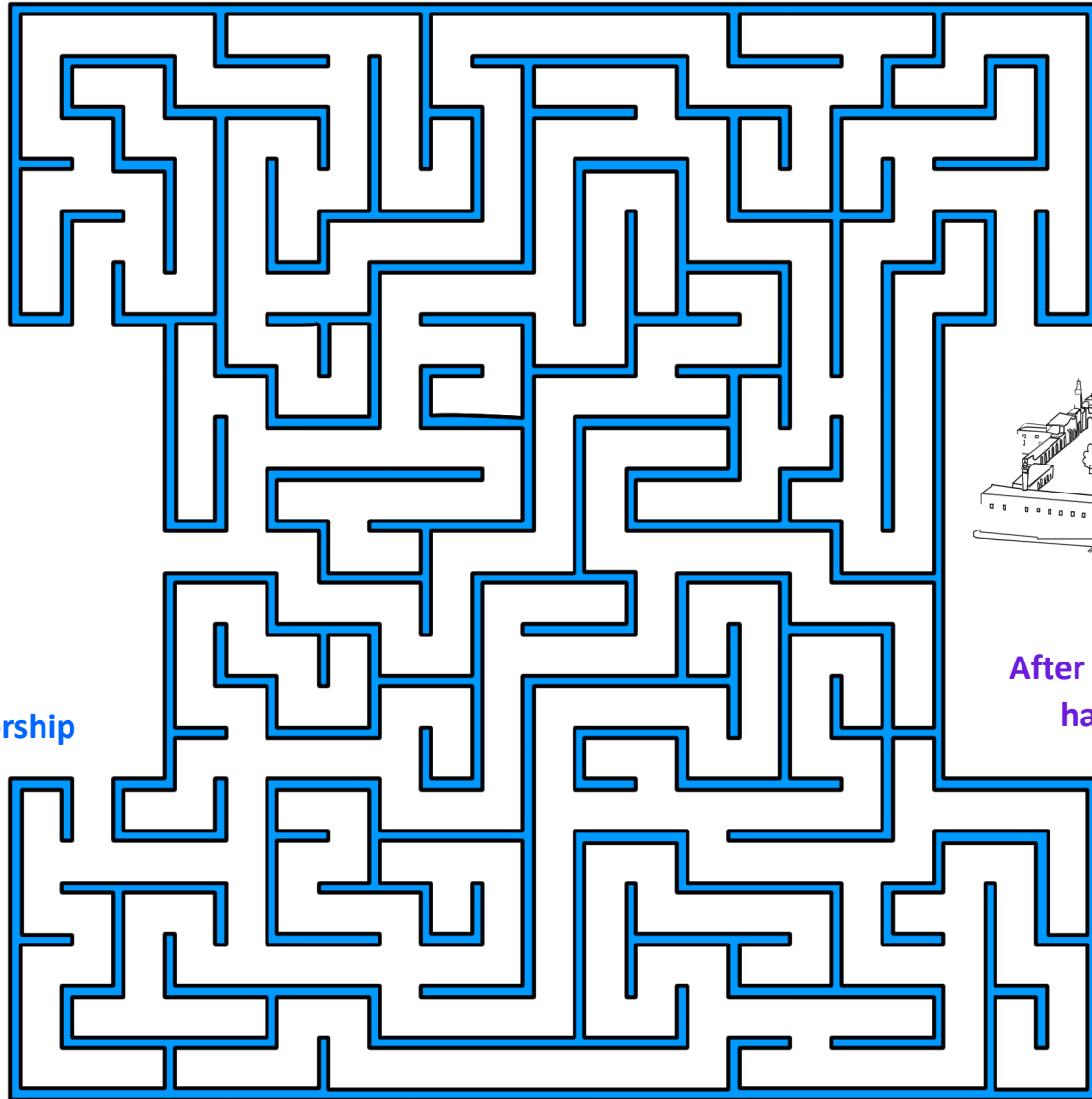

## Masjid Al-Aqsa

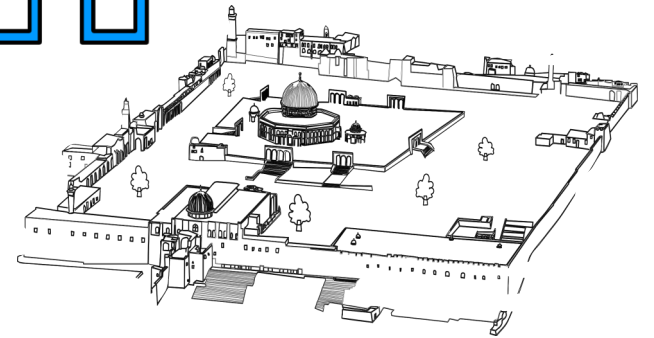

After building the Ka'bah, forty years had passed. Allah ﷻ commanded Prophet Adam عليه السلام to go to Jerusalem and build a special place of worship (Masjid Al-Aqsa).

Even today, Masjid Al-Aqsa remains a sacred and holy place.

# From Jannah to Earth

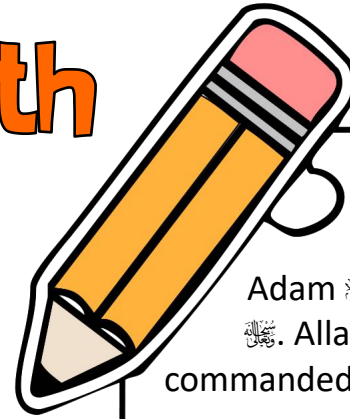

Adam ﷺ was the first man created by Allah ﷻ. Allah ﷻ made him out of **soil**. Allah ﷻ commanded the **Angels** to bow to Adam.

**Iblis** was a Jinn and was made from **fire**. He lived with the Angels who were made from light (Nur). Iblis did not **bow** down because he thought he was better than Adam ﷺ. He was very Jealous because Allah ﷻ honoured Adam ﷺ. So Iblis disobeyed Allah ﷻ and is now known as **Shaytan**.

**Adam** ﷺ lived in Jannah with his wife **Hawa**. They were very happy in Jannah. Allah ﷻ told Adam and Hawa ﷻ that they can enjoy everything in **Jannah**. However, they could not eat from one tree.

Shaytan tricked Adam and Hawa into eating from the forbidden tree. Allah sent them away from Jannah to **live** on Earth. They were very sorry and Allah ﷻ **forgave** them.

We learn about the story of Adam ﷺ in the Holy **Qur'an**. It reminds us that Allah ﷻ is the Most Merciful so we should also ask Allah ﷻ to forgive our mistakes.

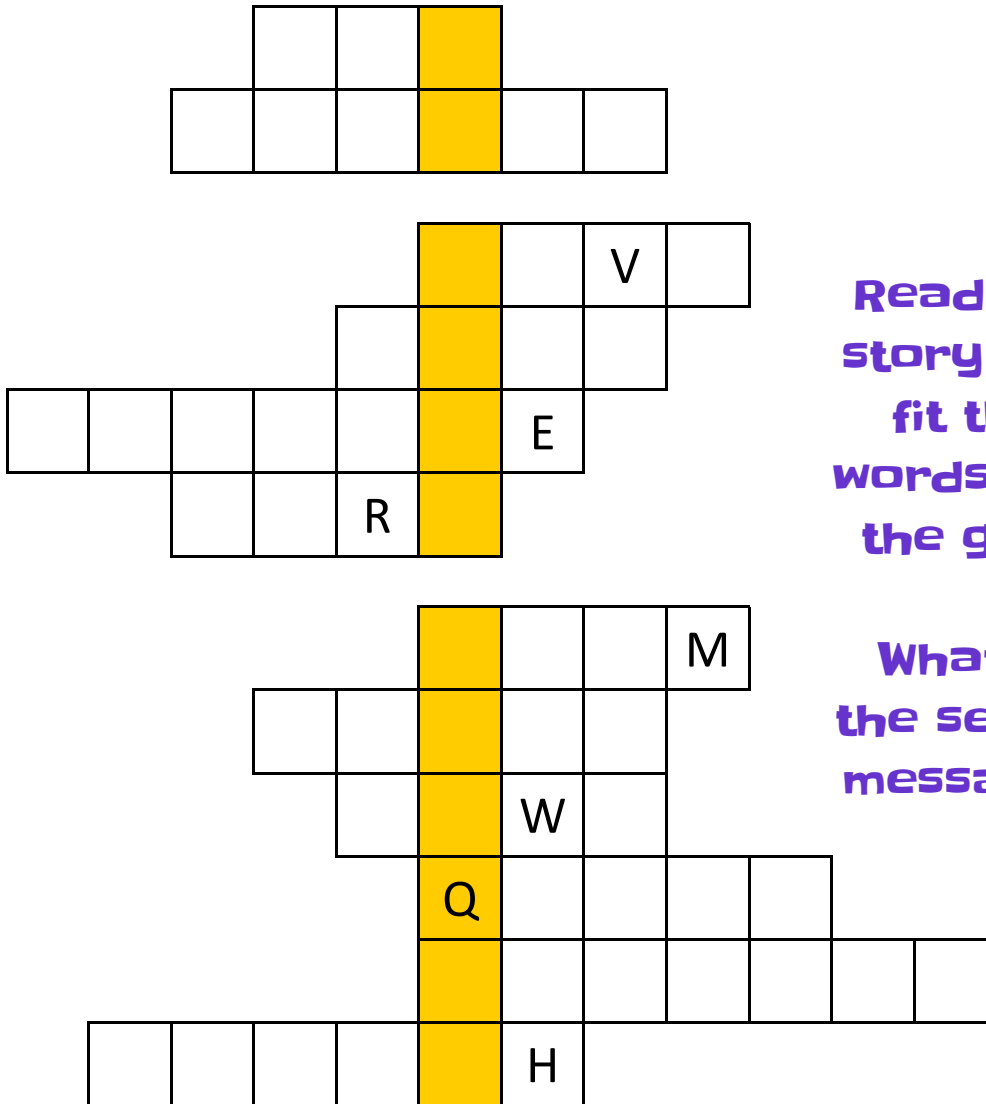

Read the story and fit the words into the grid.

What is the secret message?

# Crossword

## ACROSS

1. Where was Adam's ﷺ dua accepted?
3. Iblis was J\_\_\_\_\_ of Adam ﷺ.
5. Who was the first man created by Allah ﷻ?
6. Which was the first Masjid on Earth?
10. Where did Adam ﷺ and Hawa go after leaving Jannah?
11. What was Adam ﷺ created from?
12. Who tricked Adam ﷺ and Hawa in disobeying Allah ﷻ?
14. Adam ﷺ was the f\_\_\_\_\_ Prophet.
15. What was Iblis made from?

## DOWN

2. Masjid Al \_\_\_\_\_ is the second Masjid built on earth.
3. Where did Adam ﷺ and Hawa live first?
4. What was Adam's wife name?
7. Allah ﷻ created A\_\_\_\_\_ from light (nur)
8. Iblis was not an angel but a J\_\_\_\_\_
9. How many years after the Ka'bah did Adam ﷺ build Masjid Al-Aqsa?
13. Allah ﷻ told Adam ﷺ and Hawa not to eat from a certain t\_\_\_\_\_

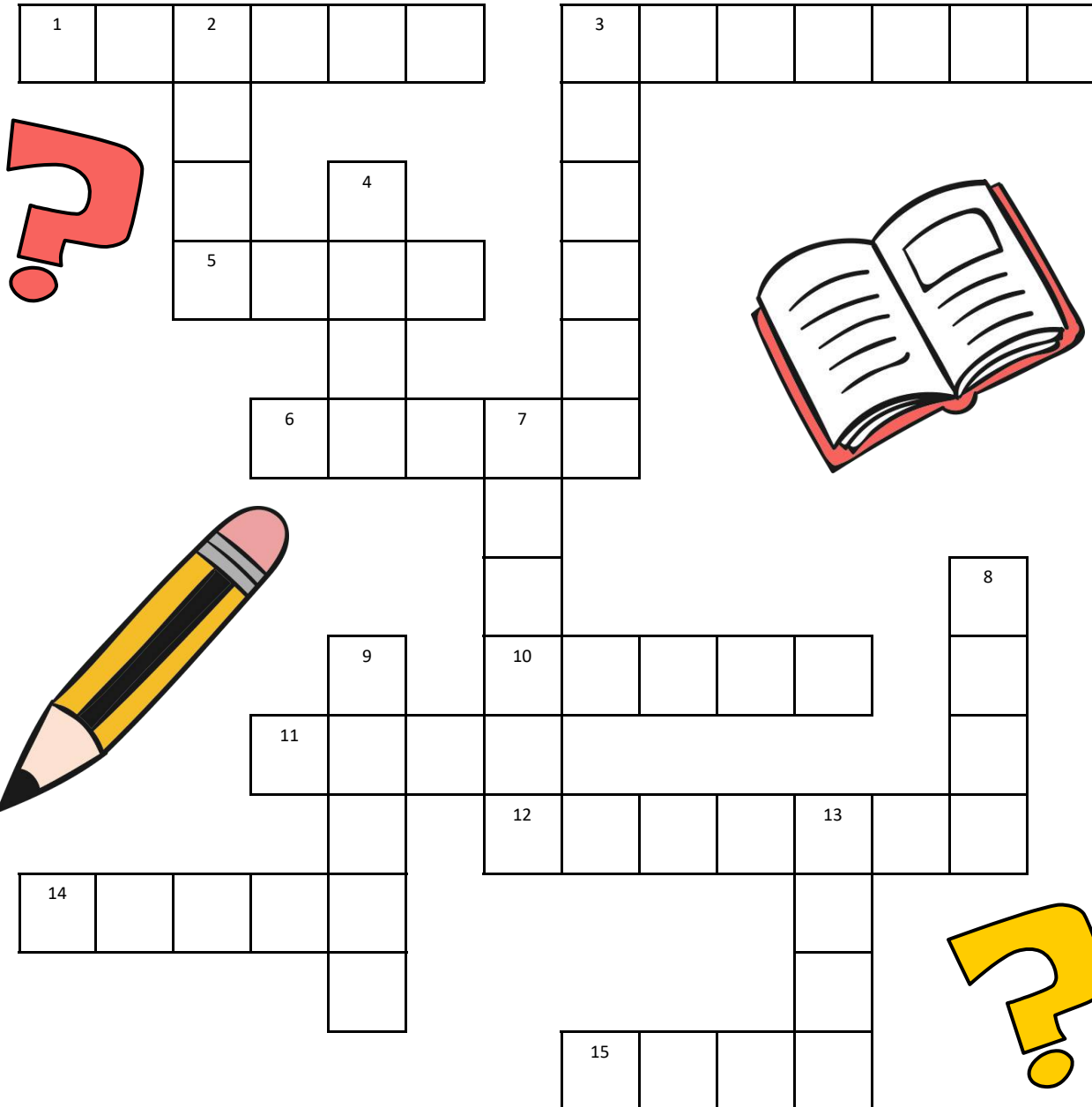



# MASJID Al-Aqsa

The Prophet ﷺ was asked,

"If one of us cannot visit it [Al-Aqsa], what should we do?"

He ﷺ said,

"Then he should make a gift of some oil to be lit therein [in its lamps]. For indeed the one who gifts this to it, will be like the one who has prayed therein".

[Ahmad]

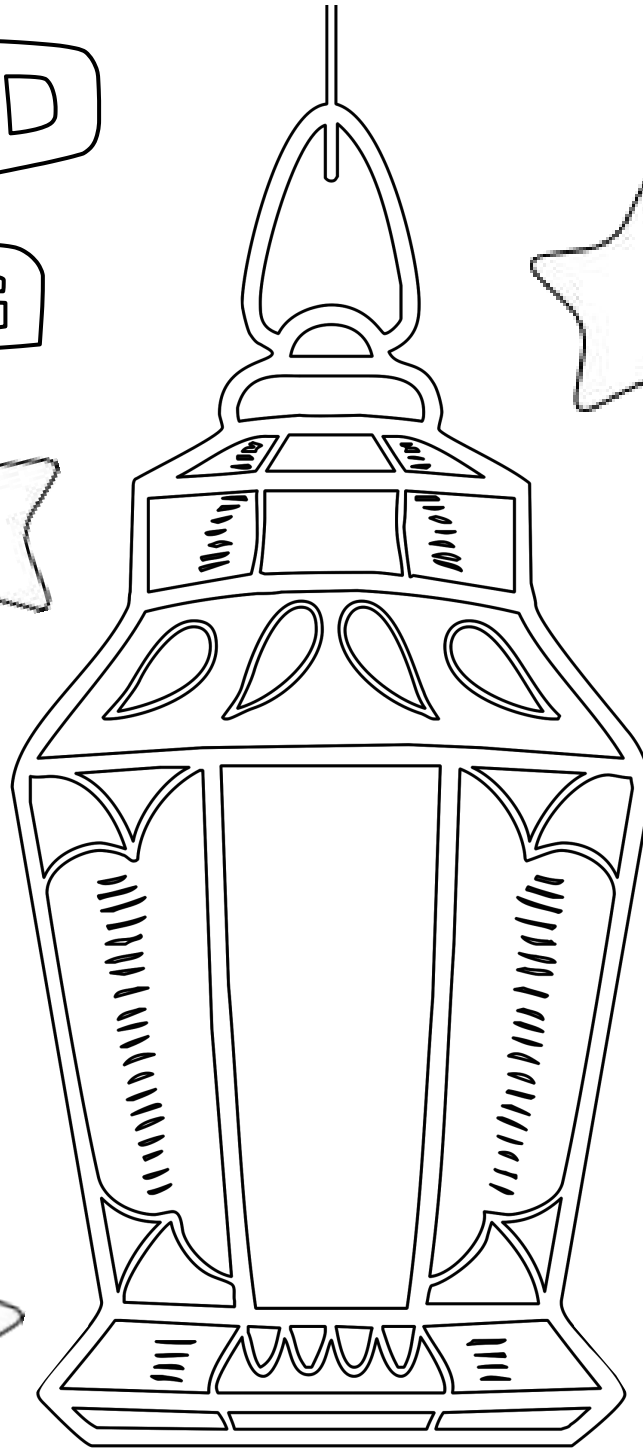

The importance of Masjid Al-Aqsa and visiting it is highlighted by our beloved Prophet Muhammad ﷺ.

If you can't travel to Masjid al-Aqsa, then send a gift for the Masjid. This will be very rewarding.

In the olden days, people used oil to light lamps when it became dark. This allowed them to study, worship and read at night time. So sending oil was helping people pray in Masjid al-Aqsa

Although oil is not used for light anymore, we can send other gifts for Masjid al-Aqsa – like helping to repair or even clean Masjid al-Aqsa.

Our Prophet Muhammad ﷺ also encouraged the Muslims to visit Masjid Al-Aqsa.

We too should learn and care about Masjid Al-Aqsa.

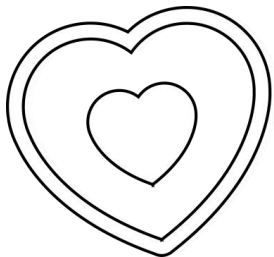
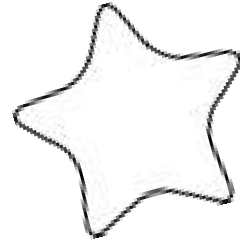
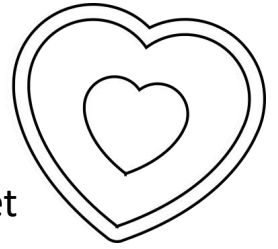

# Jealousy 1

Iblis was jealous of Prophet Adam عليه السلام because he thought he was better than Adam عليه السلام. This should be a lesson to us that we should never think we are better than another person.

Jealousy is a quality that Allah ﷻ does not like. We should try our best to remove jealousy from our hearts.

# Love for Masjid Al-Aqsa 5

Masjid Al-Aqsa was the second masjid built on Earth. This makes Masjid Al-Aqsa very special for Muslims throughout the world.

Prophet Muhammad ﷺ also loved Masjid Al-Aqsa and told the Muslims to love, look after, visit and care for Masjid Al-Aqsa.

# Time to Think



# 2

## Repentance

Allah ﷻ forgave Prophet Adam عليه السلام. This is also a big lesson for us. We should always ask Allah ﷻ for forgiveness when we do something wrong. Our sorrow and regret must be from our hearts. This is called repentance.

# 3

## Enemy of the Children of Adam

Shaytan (Iblis) became an enemy of Prophet Adam عليه السلام and his children. Allah ﷻ gave Shaytan permission to stay until the Last Day.

Shaytan wants everyone to go to Jahannam. Shaytan never gives up looking for new ways to trick us. We must always be very careful.

# 4

## Special Connection

We should always respect and care for the “houses” of Allah.

Allah ﷻ created two very special places on Earth through Prophet Adam عليه السلام. They should always have a special place in our hearts.

# Activity 2

My Name is:

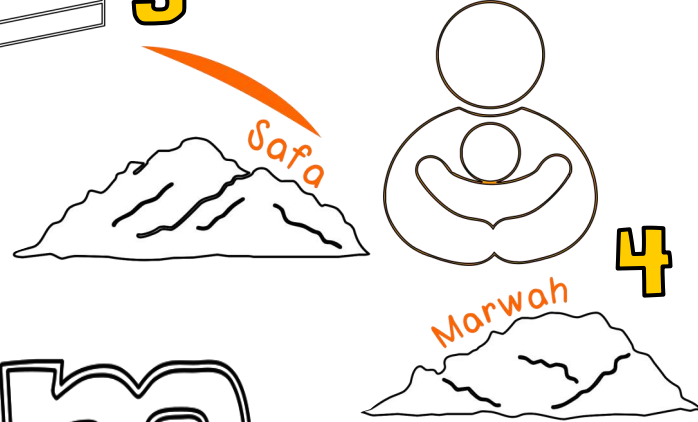
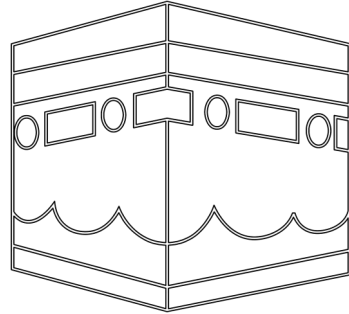
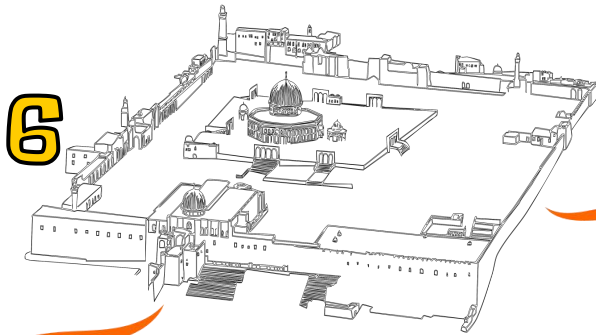

Prophet

# Ibrahim

الكاتب

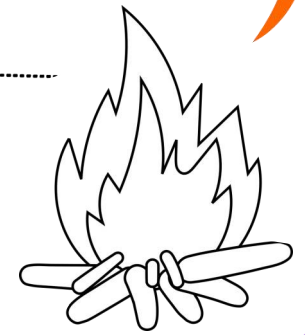
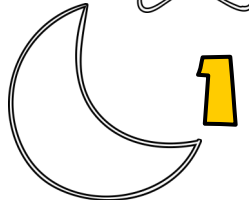
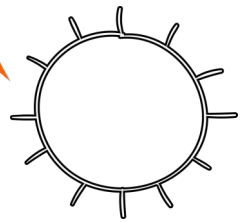

Can you re-tell the story using the pictures?



# The Story of Ibrahim عليه السلام ...

Prophet Ibrahim عليه السلام was a great prophet of Allah سبحانه وتعالى. He was given the title Khalil (friend) of Allah سبحانه وتعالى. He worshipped and dedicated his life to Allah سبحانه وتعالى.

## Idol Worship



When Ibrahim عليه السلام was a youngster he saw people making idols. The people would worship the same idols that they made themselves. Even at a young age, Ibrahim عليه السلام knew this was wrong.



## Zamzam

Ibrahim عليه السلام was commanded to leave baby Ismail and Hajar عليها السلام in an empty desert. When their water ran out, Allah سبحانه وتعالى provided Zamzam water for them.

## Tawheed

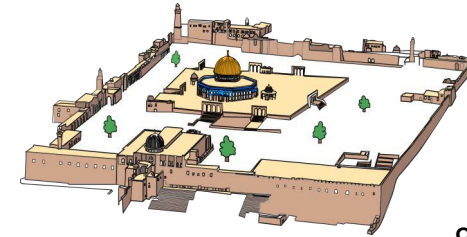

Prophet Ibrahim عليه السلام obeyed Allah سبحانه وتعالى and had great faith in Allah سبحانه وتعالى. Allah سبحانه وتعالى told Ibrahim عليه السلام to rebuild the Ka'bah and Masjid Al-Aqsa.



Prophet Ibrahim عليه السلام had two sons, Ismail عليه السلام and Ishaq عليه السلام. Our beloved Prophet Muhammad صلى الله عليه وسلم was from the descendants of Prophet Ismail عليه السلام. Many great prophets including Yusuf, Musa, Isa, Dawud, Yahya عليه السلام were from Prophet Ishaq عليه السلام.



# ZamZam

Prophet Ibrahim عليه السلام was commanded by Allah ﷻ to take his wife Hajar عليها السلام \* and baby son Ismail to an empty desert. He left them between the hills of Safa and Marwah.

Ibrahim عليه السلام left Hajar عليها السلام and Ismail some water and dates. Soon the water and food finished and baby Ismail started crying.

To look for water, Hajar عليها السلام ran up the hill of Safa. She looked in every direction for any sign of water, or any person who could help them. But she saw nothing.

Hajar عليها السلام then ran up the hill of Marwah. Again she searched for help and water. Still there was nothing. Because she was so worried, she ran between Safa and Marwah seven times to look.

When she returned, Allah ﷻ gave them His help. A spring of water miraculously gushed out of the sand near baby Ismail عليه السلام. This water is called Zamzam.

\* Hajar عليها السلام was Ibrahim's عليه السلام second wife. His first wife was Sarah عليها السلام, the mother of Ishaq عليه السلام.





# Palestine

Fit the places on the map into the grid.

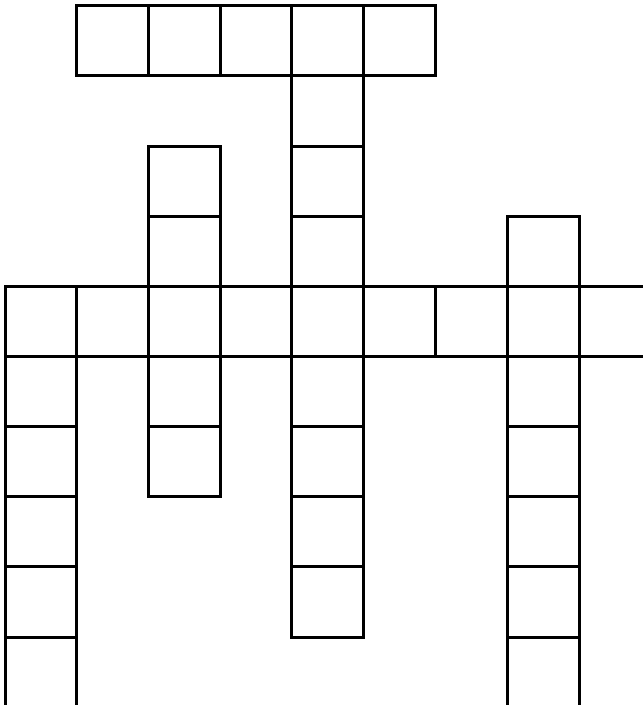

## 1. Palestine

Prophet Ibrahim عليه السلام travelled to the blessed land of Palestine and made it his home.

## 2. Jerusalem

Prophet Ibrahim عليه السلام found Masjid Al-Aqsa in ruins so he rebuilt it with his son Ishaq عليه السلام.



## 4. Ishaq

Ishaq عليه السلام continued to live in Palestine. His children lived there until the time of Yusuf عليه السلام.

## 3. Death

Prophet Ibrahim عليه السلام passed away in the blessed land of Palestine. He was buried in the town of Khalil.

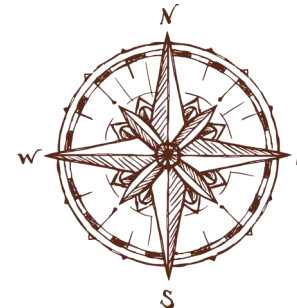

# 'Father of the Prophets'

## WORDSEARCH

Z	B	I	S	H	A	Q	G	P	I
A	F	G	J	F	B	F	C	P	S
K	J	B	M	H	K	N	G	N	M
A	F	K	U	K	Y	A	H	Y	A
R	G	J	H	M	N	G	F	M	I
I	B	R	A	H	I	M	C	N	L
Y	D	B	M	K	B	U	D	F	D
A	J	K	M	H	K	S	F	Y	N
F	I	S	A	K	D	A	W	U	D
M	D	M	D	K	B	K	C	S	C
J	D	B	M	H	Y	A	Q	U	B
S	U	L	A	I	M	A	N	F	C

Prophet Ibrahim عليه السلام is known as **Abu Al-Ambiyya** which means the father of the Prophets.

<b>Dawud</b>	•	<b>Musa</b>
<b>Ibrahim</b>	•	<b>Sulaiman</b>
<b>Isa</b>	•	<b>Yusuf</b>
<b>Ishaq</b>	•	<b>Yahya</b>
<b>Ismail</b>	•	<b>Yaqub</b>
<b>Muhammad</b>	•	<b>Zakariya</b>

The Prophets were special people selected by Allah ﷻ. Their job was to teach the people about Allah ﷻ. They also taught them that if they followed the guidance then Allah ﷻ will reward them with Jannah.

The Prophets also taught their people that Allah ﷻ is One (Tawheed).



This is 'Dome of the Rock' which is one of the 44 buildings in Masjid Al-Aqsa

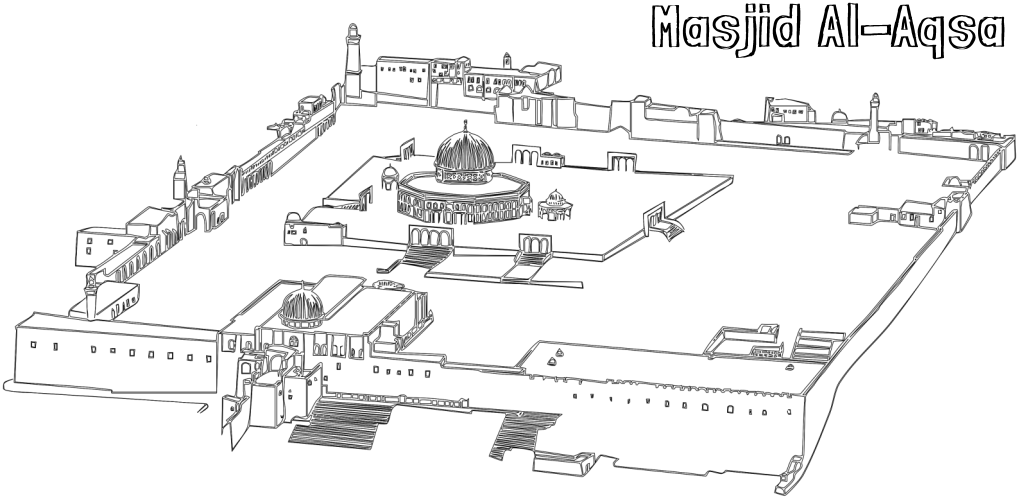
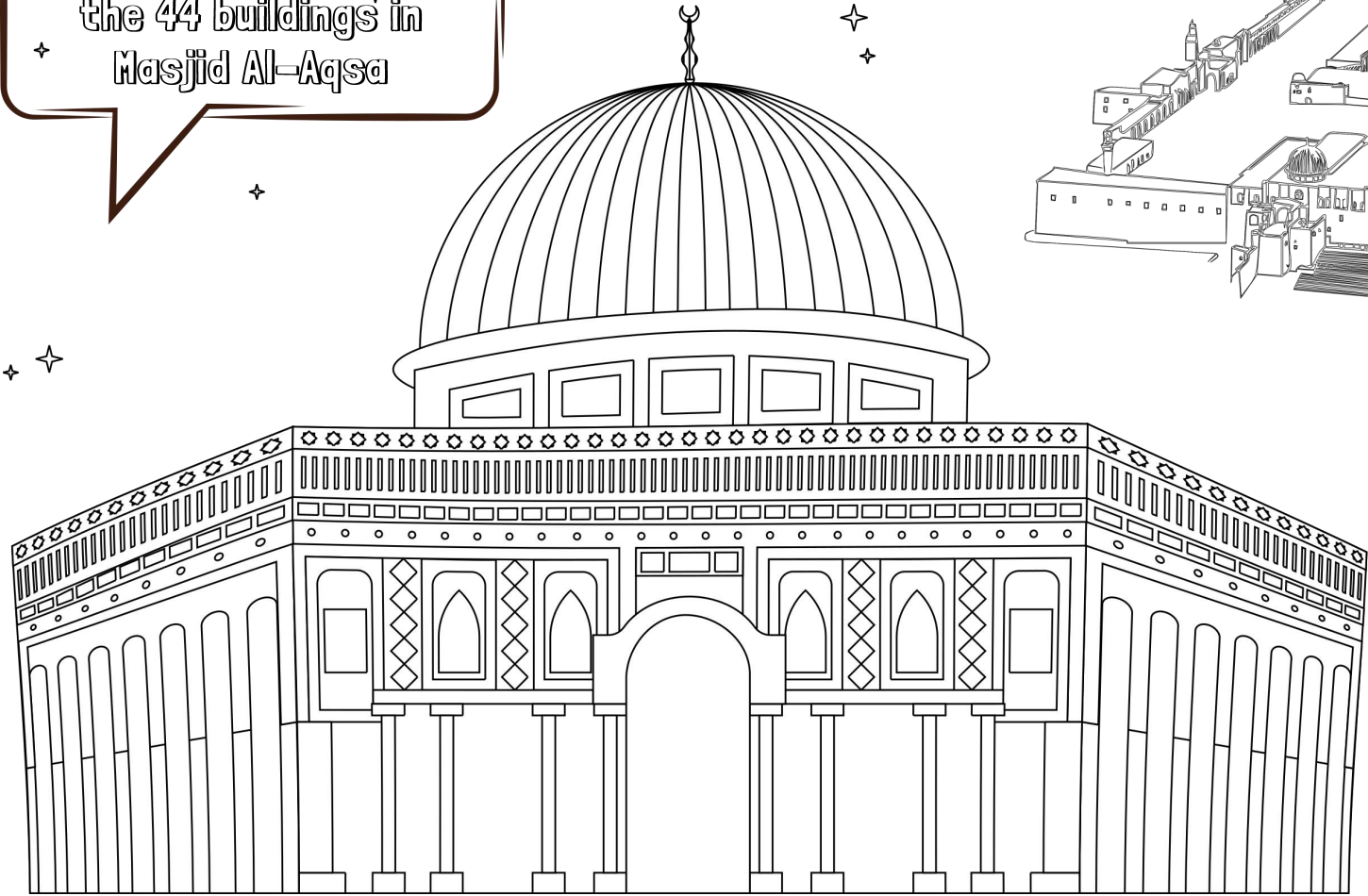

Masjid Al-Aqsa

A single prayer in Masjid AL-Aqsa has the Reward multiplied by 500!

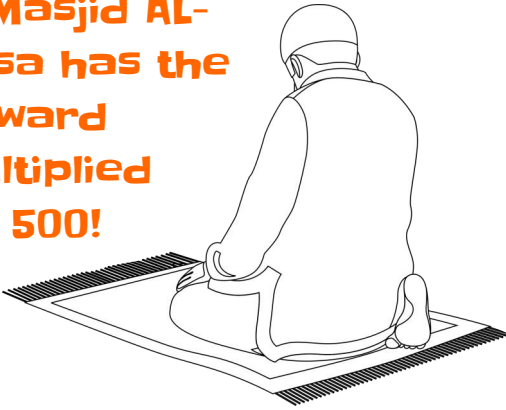

Masjid Al-Aqsa is actually an area of land in Jerusalem that includes the golden dome Masjid known as the 'Dome of the Rock'. The grey domed masjid is known as the Musallah (prayer hall of) Al-Aqsa and as Masjid Qibly.

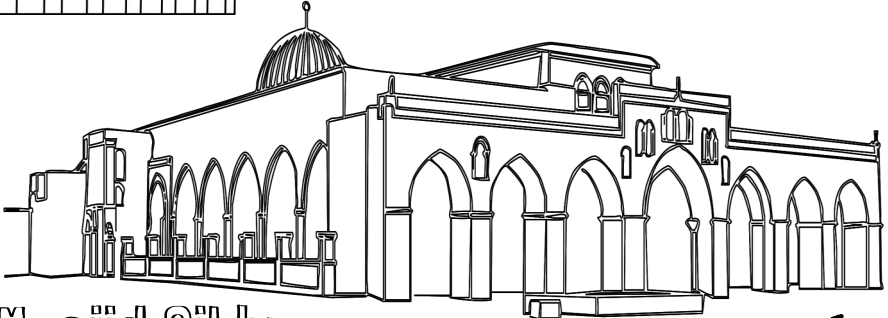

Masjid Qibly



# Time to Think

## Fitra

1

When Ibrahim عليه السلام was young, he knew that Idol worshipping was wrong.

## Dedicated to Allah ﷻ

5

Prophet Ibrahim عليه السلام was dedicated to Allah ﷻ. This means that he would always obey Allah ﷻ. This dedication to Allah ﷻ earned him a very high status amongst the prophets.

The final messenger, Prophet Muhammad ﷺ was a descendant of Prophet Ibrahim عليه السلام. He came to all mankind with guidance from Allah ﷻ.

We should also follow this guidance.



2

## Using Intellect

Prophet Ibrahim عليه السلام saw the stars and wondered if they were God. When he saw the brighter moon, he thought could this be God? At sunrise, he wondered if the bright sun could be God? Then he realised that there was only one God who created everything including the sun, moon and the stars.

3

## Special Places

Prophet Ibrahim عليه السلام went to Jerusalem and rebuilt Masjid Al-Aqsa at the exact place where prophet Adam عليه السلام had built it.

This land called Masjid al-Aqsa and indeed all of Jerusalem is sacred and blessed.

Masjid al-Aqsa is the third most sacred place in Islam.

## Trust in Allah ﷻ

4

When Prophet Ibrahim عليه السلام was thrown into the fire, Ibrahim عليه السلام knew that Allah ﷻ was with him and that Allah ﷻ would save him. Prophet Ibrahim عليه السلام always trusted Allah ﷻ throughout his life.

# Activity 3 Prophet Yusuf

يوسف

My Name is:

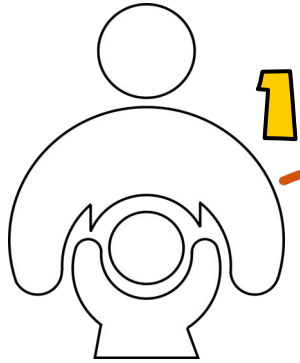

1

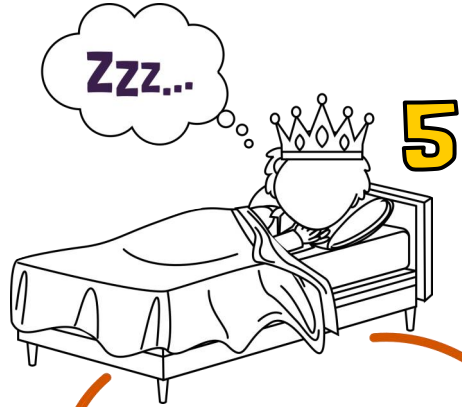

5



7

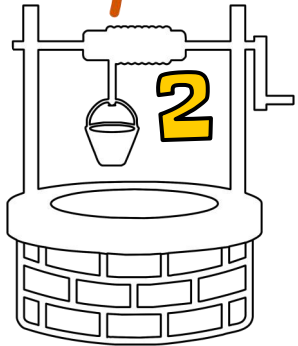

2



6



8



3

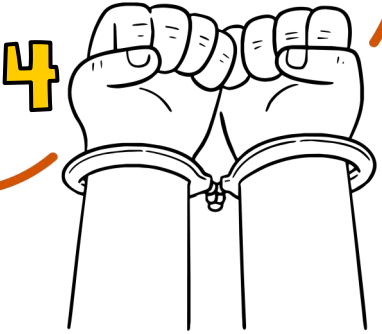

4

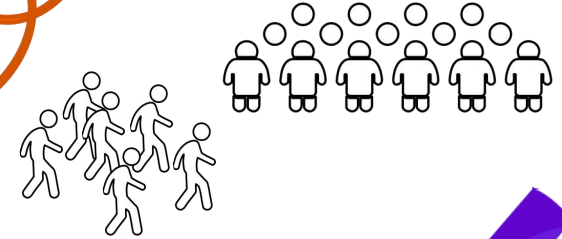

Can you re-tell the story using the pictures?



# The Story of Yusuf عليه السلام ...

Prophet Yusuf عليه السلام was the son of Prophet Yaqub عليه السلام. Yaqub عليه السلام loved Yusuf عليه السلام very much but his other brothers were jealous and plotted against Yusuf عليه السلام. As a young boy, Yusuf عليه السلام was thrown into a well by his brothers. Some travellers rescued him and sold him into slavery in Egypt to the King.



## King

Yusuf عليه السلام did not do the evil things the King's wife ordered him to do, so the king put Yusuf into prison. Prophet Yusuf عليه السلام lived in the prison for a long time where he taught the people about Tawheed - believing in only one God.



## Dreams

The King had the same dream many times. He was told that Yusuf عليه السلام had the ability to understand the meaning of dreams. After being found innocent of the original crime, Yusuf عليه السلام helped the king.



## Famine

A long famine was coming so Yusuf عليه السلام stockpiled all the extra grain in the good years and helped save the people in the famine years.



Many years later, during the famine, Yusuf's brothers came to Egypt for food. Yusuf عليه السلام forgave and welcomed them. Yusuf عليه السلام loved his family and called his father, mother and their whole family to Egypt, where he could take care of them.



# Journey to Egypt

Prophet Ishaq عليه السلام lived in Jerusalem and took care of Masjid Al Aqsa.

Which route did Yusuf عليه السلام take?

Prophet Yaqub عليه السلام had many sons who he raised near Jerusalem in Palestine.

Prophet Yaqub عليه السلام loved his son Yusuf عليه السلام very much.

Yusuf's عليه السلام brothers were very jealous of him. They threw him into a well. They then told their father that a wolf ate Yusuf عليه السلام.

Yusuf عليه السلام was taken from this well by travellers and sold as a slave in Egypt.

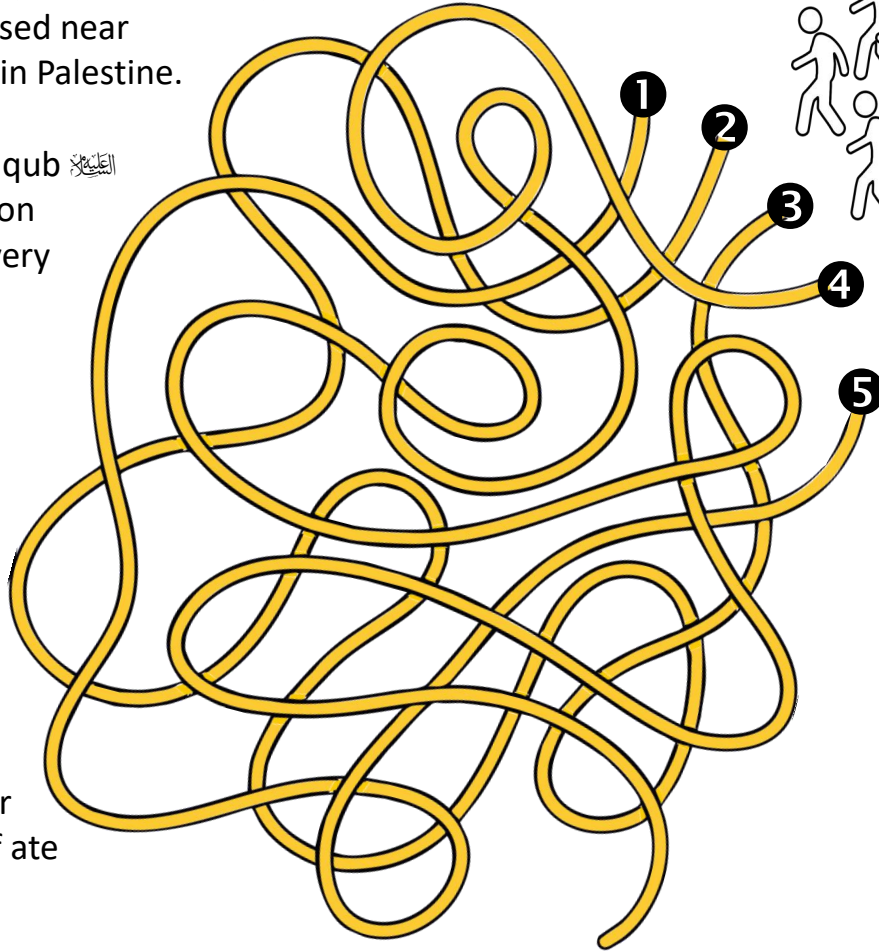
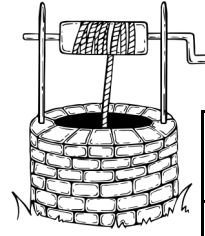

Fit the words into the grid

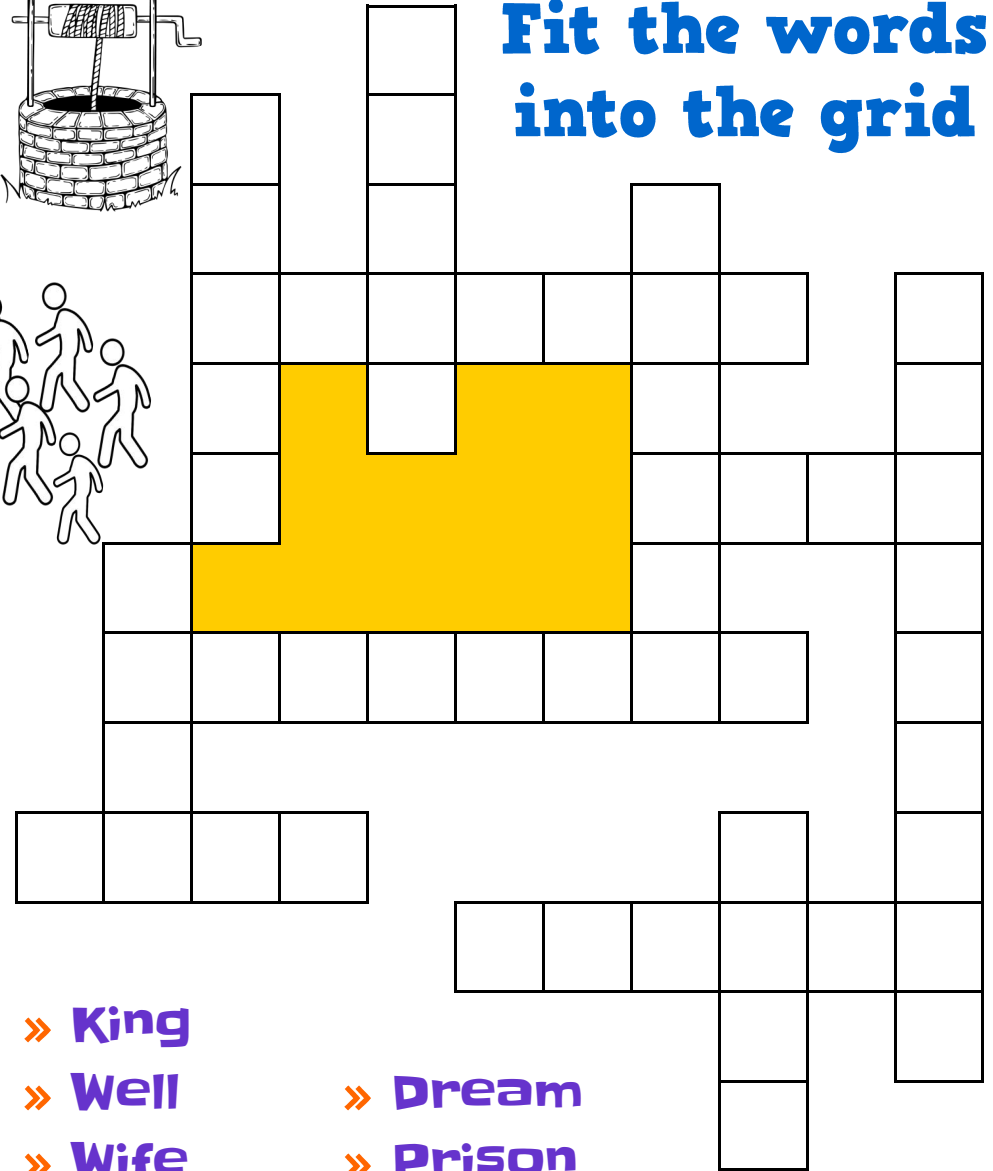

- » King
- » Well
- » Wife
- » Sabr
- » Yusuf
- » Dream
- » Prison
- » Famine
- » Slavery
- » Innocent
- » Jerusalem

# EGYPT

How is each word linked to the story of Yusuf عليه السلام ?

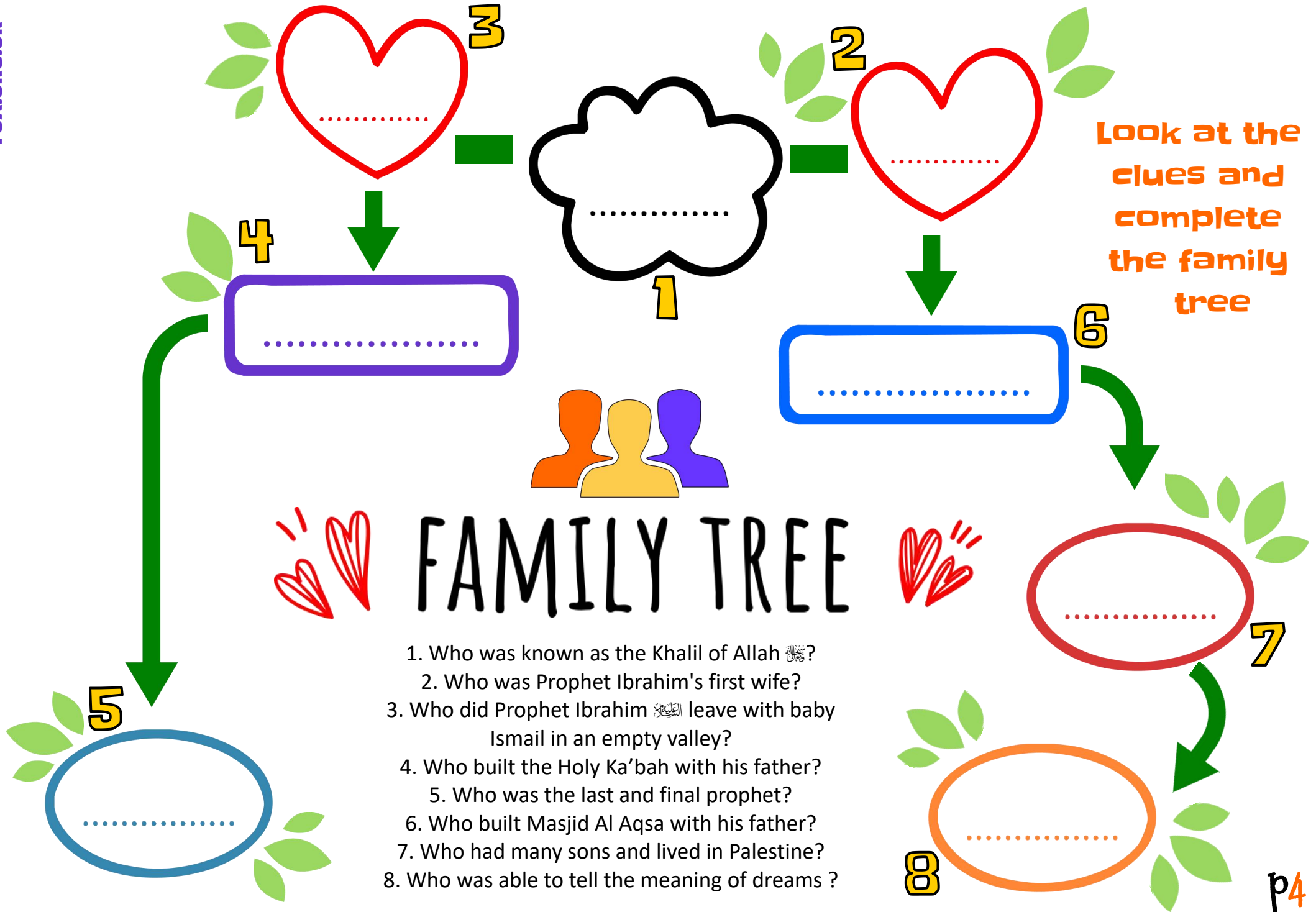

Look at the clues and complete the family tree



# FAMILY TREE



1. Who was known as the Khalil of Allah ﷺ?
2. Who was Prophet Ibrahim's first wife?
3. Who did Prophet Ibrahim ﷺ leave with baby Ismail in an empty valley?
4. Who built the Holy Ka'bah with his father?
5. Who was the last and final prophet?
6. Who built Masjid Al Aqsa with his father?
7. Who had many sons and lived in Palestine?
8. Who was able to tell the meaning of dreams?



## 1. Slavery

Yusuf عليه السلام was sold into slavery and was purchased by the King in Egypt. Yusuf عليه السلام became a servant at the king's palace.

# From Slavery to Prison

## 2. King's Wife

The King's wife wanted Yusuf عليه السلام to do something wrong but Yusuf عليه السلام refused. For this he was unjustly put into prison.

## 3. Freedom

The King needed Yusuf's عليه السلام help to interpret his dream. Yusuf عليه السلام asked for justice first so that he could clear his name.

## 4. Judge

After investigating the case fully, they realised that Yusuf عليه السلام was innocent.

Yusuf عليه السلام was freed and he was given the job to look after the food before the famine.

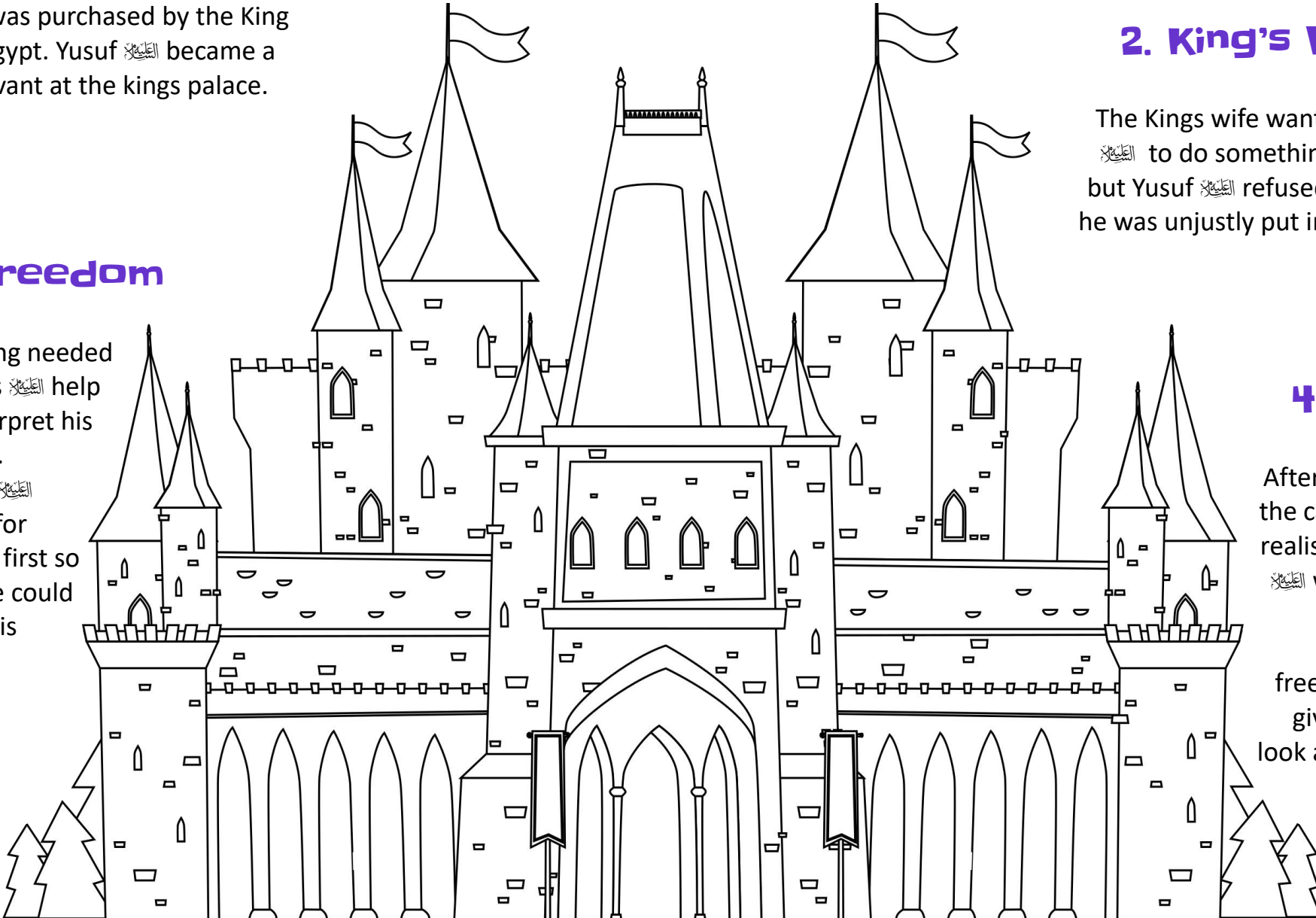

The King appointed Prophet Yusuf عليه السلام in charge of collecting and storing the grain during the years of good harvest.



When the time of famine came, the people were able to get food. The stored food helped the people survive through difficult times.

The famine also effected the people in Jerusalem. The brothers of Yusuf عليه السلام went to Egypt to get food for their families.

It was here, that Yusuf عليه السلام recognised his brothers and eventually invited them all to come and live with him in Egypt.



His father, Prophet Yaqub عليه السلام, was now an old man and tears of joy flowed from his eyes when he finally met his son Yusuf عليه السلام.

Masjid Al-Aqsa was left unattended and soon fell into ruin. The Palestinians continued to live in and around Jerusalem. Many generations grew up and lived in this blessed land.

# Helping Others

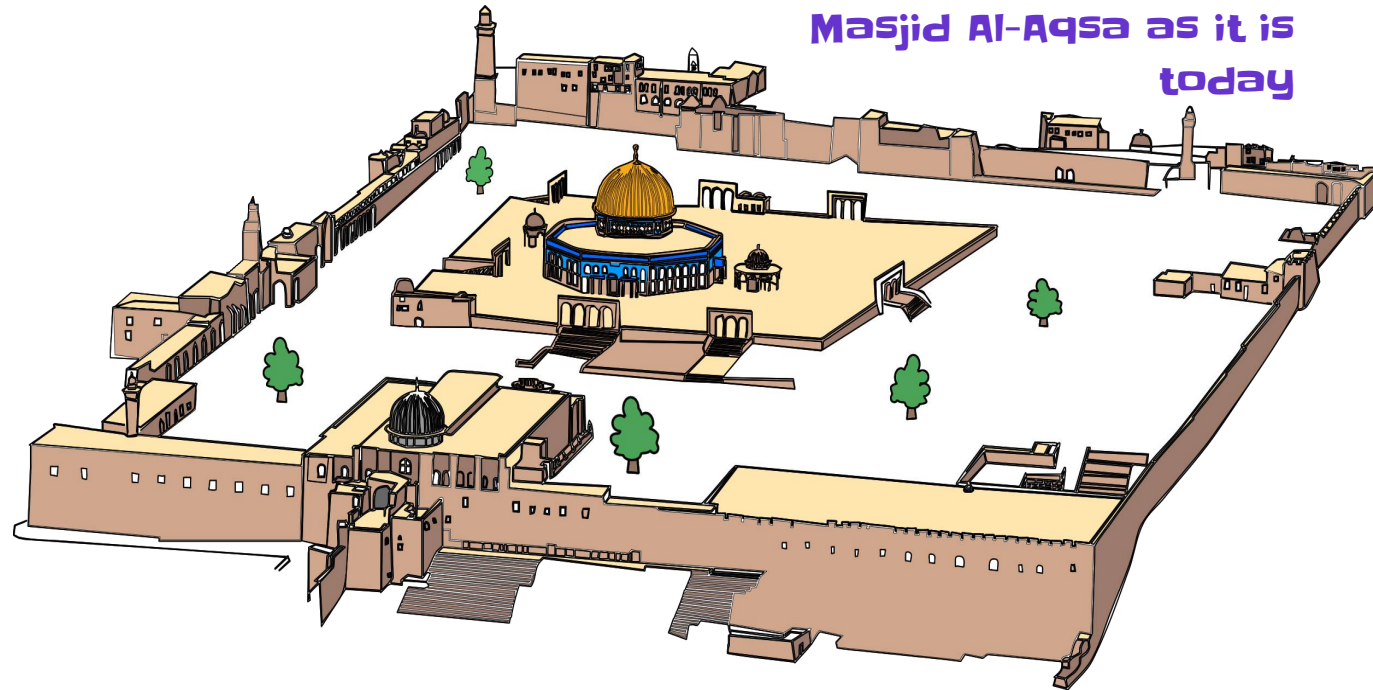

Masjid Al-Aqsa as it is today

## Kindness of Prophet Yusuf عليه السلام

During the famine, the people from Jerusalem needed food. They travelled to Egypt and asked for help. Prophet Yusuf عليه السلام helped them and gave them food. This shows the kind nature and generosity of Prophet Yusuf عليه السلام.

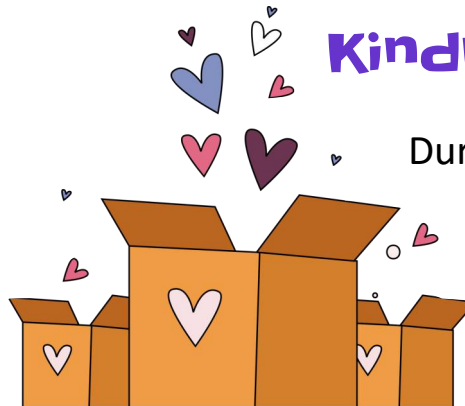

## Family

# 1

Yusuf عليه السلام went missing from his family when he was very young. His father Yaqub عليه السلام was heart broken. They met many years later when Yusuf was a young man. Yaqub عليه السلام was so happy and grateful to Allah ﷻ.

The bond of love between parents and children is special. We should love and cherish our parents.

## Forgiveness

# 5

Yusuf عليه السلام forgave his brothers when they came to Egypt for help. The brothers were overwhelmed with the generosity of Yusuf عليه السلام. The whole family left Jerusalem and began to live with him in Egypt.

We all have a duty to look after people. We should help those in need, and we should forgive others – even if they were mean to us.

# Time to Think

# 2

## Patience (Sabr)

Yusuf عليه السلام, despite being innocent, was put in prison. However, he continued to worship Allah ﷻ and remained patient.

Many years later, he was found innocent and given a very high and honoured status in Egypt. We should also have sabr when times are difficult.



## Gift

# 4

Yusuf عليه السلام was given the gift of interpreting dreams. He used this gift to help people and saved many lives.

Allah ﷻ has given us all gifts and talents. We should use them to do good.

# 3

## Jealousy

Yusuf's brothers were jealous of Yusuf عليه السلام. They knew that their father loved him very much.

Sometimes jealousy can make us do wrong things. We should not have jealousy in our hearts, but we should remove all negative emotions from our lives.